

SCHOTTKY BARRIER RECTIFIERS

FEATURES

- Metal silicon junction, majority carrier conduction
- Guarding for overvoltage protection
- Low power loss, high efficiency
- High current capability
- low forward voltage drop
- High surge capability
- For use in low voltage, high frequency inverters, free wheeling, and polarity protection applications

MECHANICAL DATA

- Case: SOD-323
- Terminals: Solderable per MIL-STD-750, Method 2026
- Approx. Weight: 5.48mg / 0.00019oz

Maximum Ratings and Electrical characteristics

Ratings at 25 °C ambient temperature unless otherwise specified.

PINNING

PIN	DESCRIPTION
1	Cathode
2	Anode



Top View
Simplified outline SOD-323 and symbol

Parameter	Symbols	KRB551V-30-7-F	Units
Peak Repetitive Reverse Voltage	V_{RRM}	30	V
DC Reverse Voltage	V_R	30	V
Maximum Average Forward Current at Ta=25°C	I_o	0.5	A
Power dissipation	P_d	200	mW
Peak Forward Surge Current, 8.3ms single half sine-wave superimposed on rated load (JEDEC method)	I_{FSM}	25	A
Maximum Instantaneous Forward Voltage	V_F	0.36 @ $I_F=100mA$ 0.47 @ $I_F=500mA$	V
Maximum DC Reverse Current at Rated DC Blocking Voltage	I_R	100 @ $V_R=20V$	uA
Storage and Operating Junction Temperature Range	T_j, T_{stg}	-55 ~ +125	°C

Fig.1 Forward Current Derating Curve

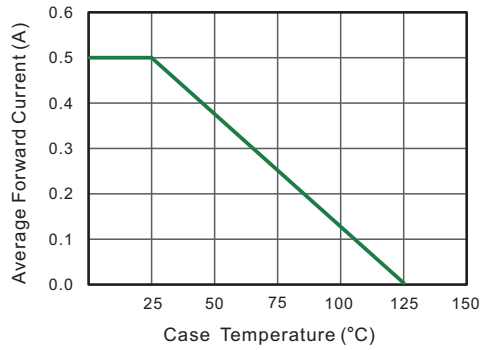

Fig.2 Typical Reverse Characteristics

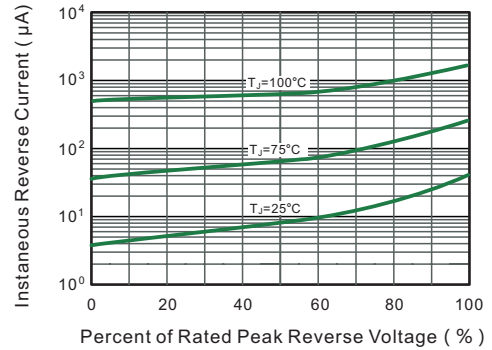

Fig.3 Typical Forward Characteristic

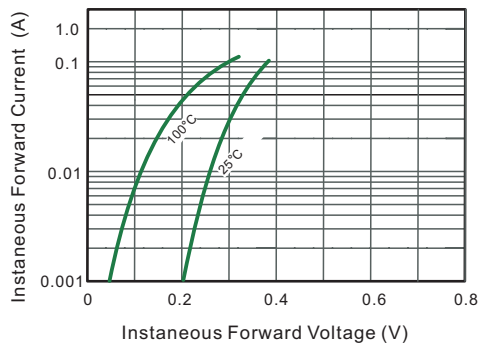

Fig.4 Typical Junction Capacitance

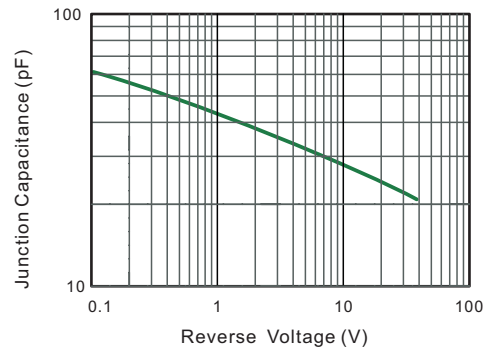
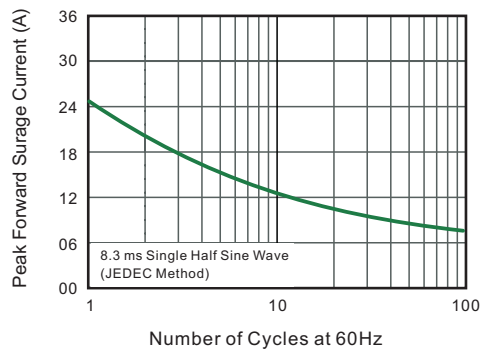

Fig.5 Maximum Non-Repetitive Peak Forward Surge Current



PACKAGE OUTLINE

Plastic surface mounted package; 2 leads

SOD-323

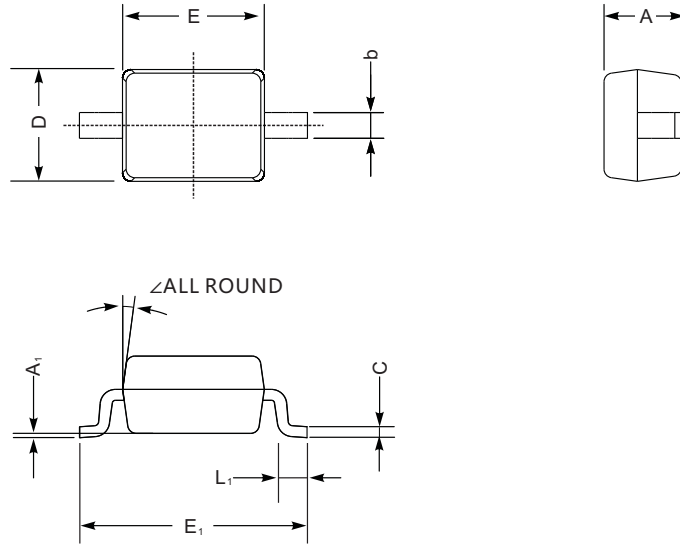

SOD-323 mechanical data

UNIT		A	C	D	E	E ₁	b	L ₁	A ₁	∠
mm	max	1.1	0.15	1.4	1.8	2.75	0.4	0.45	0.2	9°
	min	0.8	0.08	1.2	1.4	2.55	0.25	0.2	—	
mil	max	43	5.9	55	70	108	16	16	8	
	min	32	3.1	47	63	100	9.8	7.9	—	

The recommended mounting pad size

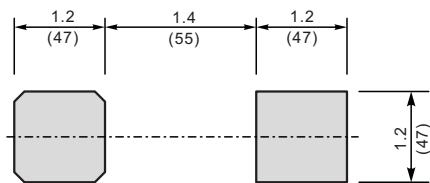

Unit: $\frac{\text{mm}}{\text{mil}}$